

EcoPulse™

Solar Charging System Controller

Installation, Operation, and Maintenance Manual

Languages: English, French, German, Spanish



For the most recent manual revisions, see the version at: www.morningstarcorp.com



MORNINGSTAR
ESSENTIAL SERIES

www.morningstarcorp.com

MODELS

EC-10

EC-10M

EC-20

EC-20M

EC-30

EC-30M

DIMENSIONS [inches (millimeters)]

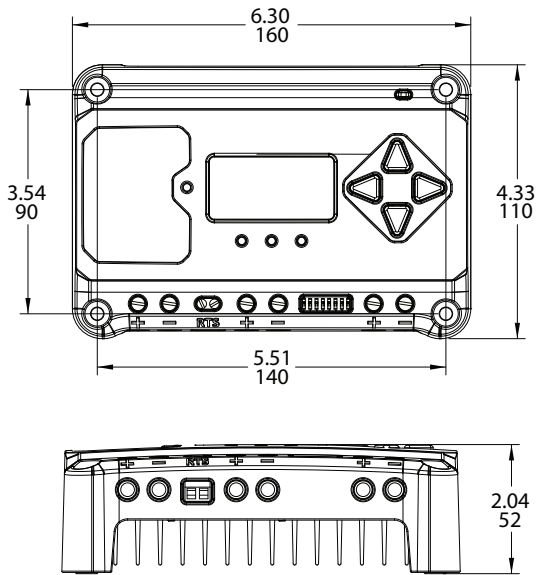

SPECIFICATION SUMMARY

	10/M	20/M	30/M
Nominal Battery voltage	12 / 24V	12 / 24V	12 / 24V
Max. PV Open- Circuit Voltage*	60V	60V	60V
Max. Battery Charging Current	10A	20A	30A
Rated Load Current	10A	20A	30A

* Array voltage should never exceed this limit

TABLE OF CONTENTS

1.0 Important Safety Instructions.....	1
2.0 General Information.....	6
2.2 Features.....	6
2.3 Optional Accessories.....	7
3.0 Installation.....	8
3.1 General Installation Notes.....	8
3.2 Configuration.....	9
3.3 Mounting.....	11
3.4 Wiring.....	13
3.5 Custom Settings.....	19
3.5.1 Adjusting the Meter Display.....	19
3.5.2 Directional Key Use and Operation / Navigating the Meter Map.....	19
3.5.3 Using the Meter Display to Program Charging Set-points and Load Control.....	19
4.0 Operation.....	20
4.1 Battery Charging Information.....	20
4.2 Load Information.....	22
4.3 LED Indications.....	22
4.3.1 Power-up.....	22
4.3.2 Status LED.....	23
4.3.3 State-of-charge LEDs.....	23

Continued

TABLE OF CONTENTS (Cont.)

4.4	Protections, Faults & Alarms.....	24
4.4.1	Protections.....	24
4.4.2	LED Fault Indication.....	24
4.4.3	Alarms.....	25
4.5	Inspection and Maintenance.....	26
5.0	Warranty.....	28
6.0	Technical Specifications.....	29
	Appendix - Certifications.....	30

1.0 IMPORTANT SAFETY INSTRUCTIONS

SAVE THESE INSTRUCTIONS.

This manual contains important safety, installation, operating and maintenance instructions for the EcoPulse solar charge controller.

The following symbols are used throughout this manual to indicate potentially dangerous conditions or mark important safety instructions:



WARNING: Indicates a potentially dangerous condition. Use extreme caution when performing this task.



CAUTION: Indicates a critical procedure for safe and proper operation of the controller.



NOTE: Indicates a procedure or function that is important to the safe and proper operation of the controller.

Safety Information

- Read all of the instructions and cautions in the manual before beginning installation.
- There are no user serviceable parts inside the EcoPulse. Do not disassemble or attempt to repair the controller.



WARNING: Risk Of Electrical Shock.
NO POWER OR ACCESSORY TERMINALS ARE ELECTRICALLY ISOLATED FROM DC INPUT, AND MAY BE ENERGIZED WITH HAZARDOUS SOLAR VOLTAGE. UNDER CERTAIN FAULT CONDITIONS, BATTERY COULD BECOME OVERCHARGED. TEST BETWEEN ALL TERMINALS AND GROUND BEFORE TOUCHING.

- External solar and battery disconnects are required.
- Disconnect all sources of power to the controller before installing or adjusting the EcoPulse.
- There are no fuses or disconnects inside the EcoPulse Do not attempt to repair.

Installation Safety Precautions

- Mount the EcoPulse indoors. Prevent exposure to the elements and do not allow water to enter the controller.
- Install the EcoPulse in a location that prevents casual contact. The EcoPulse heatsink can become very hot during operation.
- Use insulated tools when working with batteries.
- Avoid wearing jewelry during installation.
- The battery bank must be comprised of batteries of same type, make, and age.
- UL/IEC 62109 certified for use in negative ground or floating systems only
- Do not smoke near the battery bank.
- Power connections must remain tight to avoid excessive heating from a loose connection.

- Use properly sized conductors and circuit interrupters.
- This charge controller is to be connected to DC circuits only. These DC connections are identified by the symbol below:



Direct Current Symbol

The EcoPulse controller must be installed by a qualified technician in accordance with the electrical regulations of the country where the product is installed.

A means of disconnecting all power supply poles must be provided. These disconnects must be incorporated in the fixed wiring.

The EcoPulse negative power terminals are common, and must be grounded as instructions, local codes, and regulations require.

Battery Safety



WARNING: *A battery can present a risk of electrical shock or burn from large amounts of short-circuit current, fire, or explosion from vented gases. Observe proper precautions.*



WARNING: Risk of Explosion.
Proper disposal of batteries is required. Do not dispose of batteries in fire. Refer to local regulations or codes for requirements.

 **CAUTION:** When replacing batteries, use properly specified number, sizes, types, and ratings based on application and system design.

 **WARNING:** Do not open or mutilate batteries. Released electrolyte is harmful to skin, and may be toxic.

Servicing of batteries should be performed, or supervised, by personnel knowledgeable about batteries, and the proper safety precautions.

- Be very careful when working with large lead-acid batteries. Wear eye protection and have fresh water available in case there is contact with the battery acid.
- Remove watches, rings, jewelry and other metal objects before working with batteries.
- Wear rubber gloves and boots
- Use tools with insulated handles and avoid placing tools or metal objects on top of batteries.
- Disconnect charging source prior to connecting or disconnecting battery terminals.
- Carefully read the battery manufacturer's instructions before installing / connecting to, or removing batteries from, the EcoPulse.
- Be very careful not to short circuit the cables connected to the battery.
- Have someone nearby to assist in case of an accident.

- Explosive battery gases can be present during charging. Be certain there is enough ventilation to release the gases.
- Never smoke in the battery area.
- If battery acid comes into contact with the skin, wash with soap and water. If the acid contacts the eye, flood with fresh water and get medical attention.
- Be sure the battery electrolyte level is correct before starting charging. Do not attempt to charge a frozen battery.
- Recycle the battery when it is replaced.

2.0 GENERAL INFORMATION

2.1 Features

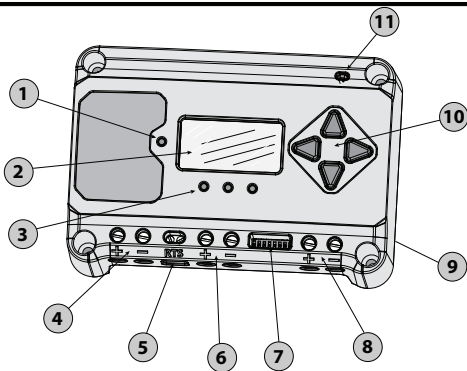

Figure 2.1. EcoPulse Features

- 1 - Charging Status / Error LED
- 2 - Meter Display (optional)
- 3 - Battery Status / Fault LED Indicators
- 4 - Solar Positive and Negative Terminals
- 5 - Remote Temperature Sensor Terminals (RTS)
- 6 - Battery Positive and Negative Terminals
- 7 - DIP Switches
- 8 - Load Positive and Negative Terminals
- 9 - Heatsink
- 10 - Meter Directional Buttons
- 11 - Local Temperature Sensor

2.2 Optional Accessories

The following accessory is available for purchase separately from your authorized Morningstar dealer:

Remote Temperature Sensor (Model: RTS)

The RTS measures battery temperature for accurate temperature compensation and is recommended when the ambient battery temperature differs from the ambient controller temperature by +/- 5° C or more. When installed, the EcoPulse will automatically use the RTS for battery temperature compensation.

3.0 INSTALLATION

3.1 General Installation Notes

- Read through the entire installation section first before beginning installation.
- Do not install in locations where water can enter the controller.
- Loose power connections and/or corroded wires may result in resistive connections that melt wire insulation, burn surrounding materials, or even cause fire. Ensure tight connections.
- For good service life, extreme temperatures and marine environments should be avoided.

 **WARNING:** Solar and battery fuses or DC breakers are required in the system. These protection devices are external to the EcoPulse controller, and must be a maximum of 15 Amps for the EcoPulse-10/M, 30 Amps for the EcoPulse-20/M, and 40 Amps for the EcoPulse-30/M.

 **WARNING:** All breakers must be properly rated for wire ampacity, which may require less than the maximum breaker sizes referenced above.

 **WARNING:** Minimum over-current protection device interrupt ratings must be 2000A for 12V systems, and 4000A for 24V systems.

 **NOTE:** Carefully observe the LEDs after each connection. The LEDs will indicate proper polarity, and a secure connection.

3.2 Configuration

The DIP switch block shown below is used to set the operating parameters for the EcoPulse.

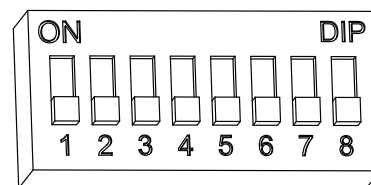

Switch 1: Lighting Control

With DIP 1 ON, a light connected to the load terminals will be On from dusk-dawn.

Switches 2, 3: System Voltage

Three (3) system voltage configurations are available as shown in the table below:

System Voltage	Switch 2	Switch 3
Auto	OFF	OFF
12	OFF	ON
24	ON	OFF

NOTE: Before connecting the battery, measure the open-circuit voltage. It must be over 10 Volts to start the controller. (Cont.)

If the system voltage DIP Settings Switches are set to Auto-detect, battery voltage over 15.5V will be detected as a 24V nominal battery, and the unit will charge accordingly.

The 12/24V auto selection is done only at start-up, and the detected system voltage will never change during operation. It is recommended to set DIPs 2 and 3 to the correct system voltage setting. Only use the default auto-detect setting if the nominal system voltage is not known.

Switches 4, 5, 6: Battery Type Selection

Preset EcoPulse battery charging options are shown in table 3-1 below. All voltage settings listed are for nominal 12 Volt batteries. Multiply the voltage settings by two (2) for 24 Volt systems.

 **NOTE:** These settings are general guidelines for use at the operator's discretion. Consult the battery manufacturer for optimal battery charge settings.

DIP Switch Settings 4-5-6	Battery Type	Absorp. Stage (volts)	Float Stage (-volts)	Equalize Stage (volts)	Absorp. Time (mins)	Equalize Time (mins)	Equalize Timeout (mins)	Equalize Interval (days)	LVD (volts)	LVR (volts)
off-off-off	1 - Sealed*	14.00	13.50		150				11.50	12.60
off-off-on	2 - Sealed*	14.15	13.50	14.40	150	60	120	28	11.30	12.80
off-on-off	3 - Sealed*	14.30	13.50	14.60	150	60	120	28	11.50	13.00
off-on-on	4 - AGM/Flooded	14.40	13.50	15.10	180	120	180	28	11.70	13.20
on-off-off	5 - Flooded	14.60	13.50	15.30	180	120	180	28	11.90	13.40
on-off-on	6 - Flooded	14.70	13.50	15.40	180	180	240	28	12.10	13.60
on-on-off	7 - L-16	15.40	13.40	16.00	180	180	240	14	12.30	13.80
on-on-on	8 - Custom	Custom	Custom	Custom	Custom	Custom	Custom	Custom	Custom	Custom

* "Sealed" battery type includes gel and AGM batteries

Table 3.1. Battery charging settings for each selectable battery type

Switch 7: Battery Equalization

Mode	Switch 7
Manual Equalization	OFF
Auto Equalization	ON

NOTE: Regardless of DIP 7 setting, manual EQ can be initiated using the on-board meter command, "Start Equalize". For non-meter versions, DIP 7 only enables or disables auto equalization - manual EQ is not available.

Switch 8: Current Switching

Mode	Switch 8
PWM switching	OFF
Slow switching	ON

The default (PWM) switching setting (OFF / down) operates at 300Hz. If load or system noise is an issue, DIP 8 can be set (ON-up) for slow switching at 1Hz. Standard PWM switching is recommended when system noise is not a problem.

3.3 Mounting

Inspect the controller for shipping damage. Mount the EcoPulse to a vertical surface (4-#8 stainless steel self-tapping screws are included). Tighten the mounting screws using care not to crack the plastic case. Do not install directly over an easily combustible surface since the heat sink may get hot under certain operating conditions.

 **NOTE:** The heat sink must be in a vertical position (fins up and down).

For proper air flow, allow at least 15 cm (6 in) of space above and below the controller, and 50 mm (2 in) at the sides - see Figure 3-1 below. Install in an area protected from direct rain and direct sun.

If the controller is installed in an enclosure, some ventilation is recommended. Do not locate in an enclosure where battery gases can accumulate.

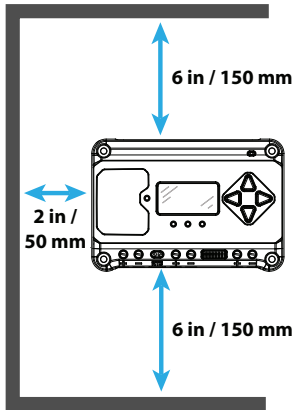

Figure 3-1. Proper Clearances for Passive Cooling

3.4 Wiring

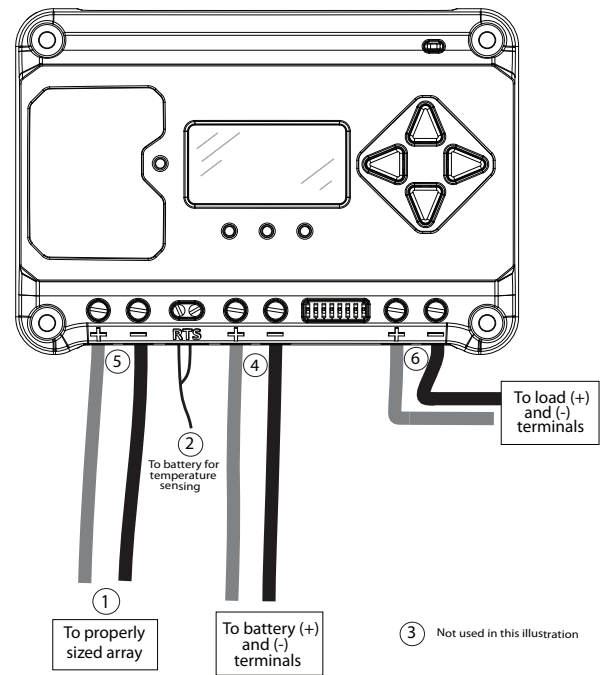

Figure 3-2. Wiring the EcoPulse

REFER TO FIGURE 3.2 WHEN USING THE FOLLOWING WIRING INSTRUCTIONS

STEP 1: Check Controller Limitations

Verify that the highest temperature compensated solar array open-circuit voltage (Voc), and load current do not exceed the ratings of the EcoPulse version being installed.

STEP 2: Remote Temperature Sensor



WARNING: Risk of Fire.

If no Remote Temperature Sensor (RTS) is connected, use the EcoPulse within 3m (10 ft) of the batteries. Internal Temperature Compensation will be used if the RTS is not connected. Use of the RTS is strongly recommended.

Connect the RTS to the 2-position terminal located (see figure). There is no polarity, so either wire (+ or -) can be connected to either screw terminal.



WARNING: Equipment Damage.

Never place the temperature sensor inside a battery cell. Both the RTS and the battery will be damaged.



CAUTION: The EcoPulse will use the local temperature sensor for compensation if the RTS is not used.

STEP 3: Grounding



NOTE: Depending on the country of installation, conductors identified by the color green, or a combination of green / yellow, shall only be used for earthing conductors.

For safety, and effective lightning protection, it is recommended, and may be locally required, that the negative conductor of the charging system be properly grounded. Use only one system earth ground. For conductor sizing requirements, refer to the U.S. National Electrical Code, or applicable local regulations or code.

STEP 4: Battery Connections

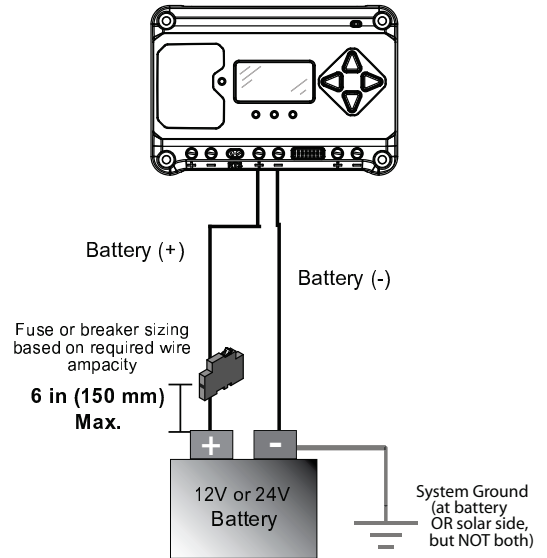

Be sure that DIP switches 2 and 3 are set for 12 or 24V, as described in Section 3.2.

NOTE: Before connecting the battery, measure the open-circuit voltage. It must be over 10 Volts to start the controller. With the battery disconnect open, connect the battery (+) and (-) wires from the battery to controller. **DO NOT CLOSE THE DISCONNECT AT THIS TIME.**

STEP 5: Solar Connections

WARNING: Shock Hazard. The solar PV array can produce open-circuit voltages of up to 60 Vdc when in sunlight, and this DC voltage is supplied to the Power Conversion Equipment (PCE). Verify that the solar input breaker or disconnect has been opened (disconnected) before installing the system wires.

NOTE: For design purposes, array should be nominal 12V for 12V battery, and nominal 24V for 24V battery. Do not exceed 60Voc

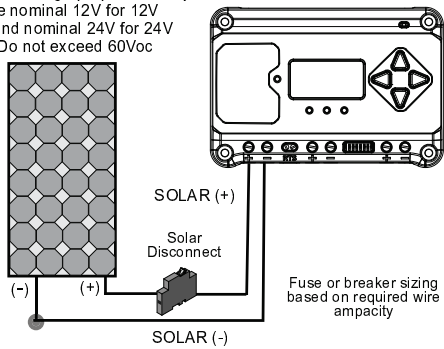

With the solar disconnect open, connect the solar (PV) array wires to the EcoPulse solar terminals. Use caution, since the solar array will produce current whenever in sunlight. **DO NOT CLOSE THE DISCONNECT AT THIS TIME.**

STEP 6: Load Connections

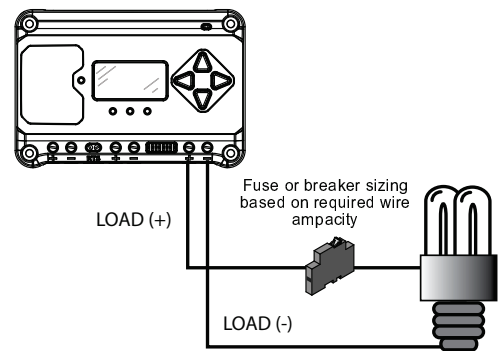

Turn the loads off, and connect the load wires to the load terminals. **DO NOT CLOSE THE FUSE OR BREAKER AT THIS TIME.**

STEP 7: Power-Up and Verify System Operation

Close the battery disconnect to start the processor, and activate the controller's protections. Watch the charging status, and then the three battery state-of-charge (SOC) LEDs blink in sequence (G-Y-R), confirming proper start-up. If they do not light, check the battery polarity (+/-) and battery voltage.

The green, yellow or red LED will light depending on the battery state-of-charge (SOC). Confirm that one of these LEDs is on before going to the next step.

Close the solar disconnect. If the solar input is connected while in sunlight, the charging LED indicator will light. Confirm proper connection by observing the charging LED.

Insert the load fuse, or close the breaker, and turn the load on to confirm a proper connection.

STEP 8: To Power-Down



WARNING: Risk of Damage.

ONLY disconnect the battery from the EcoPulse AFTER the solar input has been disconnected. Damage to the controller may result if the battery is removed while the EcoPulse is charging.

- To prevent damage, power-down must be done in the reverse order as power-up.

3.5 Custom Settings

3.5.1 Adjusting the Meter Display

The display setting options are adjustable by using the directional keys to locate and edit a desired display setting.

3.5.2 Directional Key Use and Operation / Navigating the Meter Map

A lit key indicates a valid direction in the meter map. The current location is indicated on the display with a column heading, and a bold descriptor.

3.5.3 Using the Meter Display to Program Charging Set-points and Load Control

From the top level monitoring screens, scroll down to the Main Menu - "Custom Programming" - screen. Select the desired category, and edit the variable or setting as instructed in the meter display.

4.0 OPERATION

4.1 Battery Charging Information

4-Stage Charging

The EcoPulse has a 4-stage battery charging algorithm for rapid, efficient, and safe battery charging. Figure 4-1 below, shows the sequence of stages.

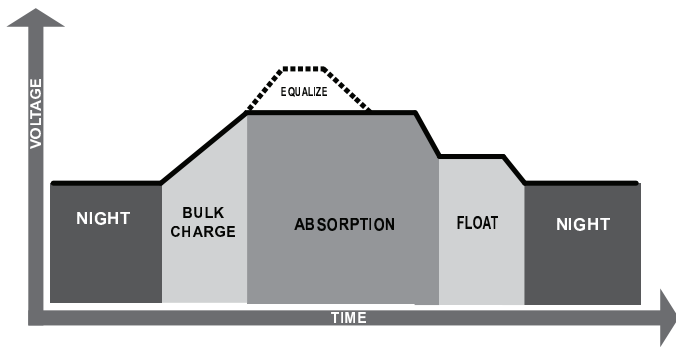

Figure 4.1. EcoPulse Charging Algorithm

Bulk Charge Stage

During Bulk charging, the battery is not at 100% state of charge and battery voltage has not yet charged to the Absorption voltage set-point. The controller will deliver 100% of available solar power to recharge the battery.

Absorption Stage

When the battery has recharged to the Absorption voltage set-point, constant voltage regulation is used to maintain battery voltage at the Absorption set-point.

Float Stage

After the battery is fully charged in the Absorption stage, the EcoPulse reduces the battery voltage to the Float voltage set-point. The purpose of float is to protect the battery from long-term overcharge.

Equalization Stage



WARNING: Risk of Explosion.

Equalizing vented batteries produces explosive gases. The battery bank must be properly ventilated.



CAUTION: Equipment Damage.

Equalization increases the battery voltage to levels that may damage sensitive DC loads. Verify all system loads are rated for the temperature compensated Equalize voltage before beginning an Equalization charge.

4.4 Protections, Faults and Alarms

4.4.1 Protections

Solar, battery and load transient surges

Power-up against any active faults

Reverse Polarity - battery and array

Solar Short-Circuit

Solar High Voltage Disconnect

High Heatsink Temperature - Load disconnect

Load Short-Circuit

Load Over-Current

Heatsink Temperature Limit

RTS Terminals

Battery Sense Terminals

4.4.2 LED Fault Indications

Solar Over-current

Error status LED: Flashing red. Battery status LEDs: R/Y-G sequencing

Load Over-current

Error Status LED: Flashing red. Battery status LEDs: R/Y-G sequencing

Solar Short Circuit

Charging Status LED: OFF

Battery Reverse Polarity

No LED indication, the unit is not powered

Load Short Circuit

Error status LED: Flashing red. Battery status LEDs: R/G-Y sequencing

Solar High Voltage Disconnect

Charging Status LED: R flashing

Remote Temperature Sensor (RTS)

Error status LED: Flashing red. Battery status LEDs: R/Y - G/Y sequencing

Battery / Load High Voltage disconnect (HVD)

Error status LED: Flashing red. Battery status LEDs: R-G sequencing

High Heatsink Temperature

Error status LED: Flashing red. Battery status LEDs: R-Y sequencing

Settings (DIP) Switch Changed

Error status LED: Flashing red. Battery status LEDs: R-Y-G sequencing

Custom Settings Edit

Error status LED: Flashing red. Battery status LEDs: R-Y-G sequencing

Internal Power Supply Out of Range

Error status LED: Solid red. Battery status LEDs: R-Y-G sequencing. Contact your Morningstar dealer for service

4.4.3 Alarms

High Temperature Current Limit

RTS Open

Heatsink Temperature Sensor Open or Shorted

Battery Sense Out of Range, or Disconnected

Uncalibrated

4.5 Inspection and Maintenance

Table 4.3 below lists the recommended maintenance schedule to keep your EcoPulse performing optimally.

Schedule	Maintenance Items
2 weeks after installation	Re-tighten power terminal connections to specified torque values.
3 months after installation	Re-tighten power terminal connections to specified torque values.
Monthly, or After Each Equalization	<p>Inspect the battery bank. Look for cracked or bulging cases, and corroded terminals.</p> <p>For wet cell -flooded type batteries, make sure the water level is correct. Wet cell water levels should be checked monthly according to the manufacturer's recommendations.</p>

Table 4.3. Maintenance Schedule (Cont.)

Schedule	Maintenance Items
Monthly, or After Each Equalization	<p>Inspect the battery bank. Look for cracked or bulging cases, and corroded terminals.</p> <p>For wet cell (flooded type) batteries, make sure the water level is correct. Wet cell water levels should be checked monthly or according to the manufacturer's recommendations.</p>
Annually	<p>Clean the heatsink fins with a clean, dry rag.</p> <p>Inspect all wiring for damage or fraying.</p> <p>Inspect for nesting insects.</p> <p>Re-tighten all wiring terminal connections to specified torque values.</p> <p>Inspect the system earth grounding for all components. Verify all grounding conductors are appropriately secured to earth ground.</p>

Table 4.3. Maintenance Schedule (End)

5.0 WARRANTY

LIMITED WARRANTY Morningstar Solar Controllers and Inverters

The EcoPulse is warrantied to be free from defects in material and workmanship for a period of TWO (2) years from the date of shipment to the original end user. Morningstar will, at its option, repair or replace any such defective units.

WARRANTY EXCLUSIONS AND LIMITATIONS:

This warranty does not apply under the following conditions:

- ◆ Damage by accident, negligence, abuse or improper use
- ◆ PV or load currents exceeding the ratings of the product
- ◆ Unauthorized product modification or attempted repair
- ◆ Damage occurring during shipment
- ◆ Damage results from acts of nature such as lightning and weather extremes

THE WARRANTY AND REMEDIES SET FORTH ABOVE ARE EXCLUSIVE AND IN LIEU OF ALL OTHERS, EXPRESS OR IMPLIED. MORNINGSTAR SPECIFICALLY DISCLAIMS ANY AND ALL IMPLIED WARRANTIES, INCLUDING, WITHOUT LIMITATION, WARRANTIES OF MERCHANTABILITY AND FITNESS FOR A PARTICULAR PURPOSE. NO MORNINGSTAR DISTRIBUTOR, AGENT OR EMPLOYEE IS AUTHORIZED TO MAKE ANY MODIFICATION OR EXTENSION TO THIS WARRANTY.

MORNINGSTAR IS NOT RESPONSIBLE FOR INCIDENTAL OR CONSEQUENTIAL DAMAGES OF ANY KIND, INCLUDING BUT NOT LIMITED TO LOST PROFITS, DOWN-TIME, GOODWILL OR DAMAGE TO EQUIPMENT OR PROPERTY.

R17-8/16

6.0 TECHNICAL SPECIFICATIONS

EC-10/M EC-20/M EC-30/M

Electrical:

Nominal battery voltage	All: 12 or 24 Volts		
Battery voltage range	All: 10-35 Volts		
Max. Battery Current	10A	20A	30A
Max. PV open-circuit voltage	All: 60 Volts		
Load Current Rating	10A	20A	30A
Self Consumption	<15mA (non-meter)		<20mA (meter)

Mechanical:

Dimensions:	6.01(W) x 4.14(L) x 2.17(D) in. 153(W) x 105(L) x 55(D) mm		
Weight (lb/kg): Non-metered:	0.75 / 0.34	1.1 / 0.48	
Metered:	0.90 / 0.40	1.2 / 0.54	
Wire Size Range:	2.5 - 16 mm ² / #14 - 6 AWG		
Power Terminals	35 in-lb		
Maximum Torque	0.25 - 1.0 mm ² / #24 - 16 AWG		
Battery/Temp. Sense	IP20, Type 1		
Enclosure			

Battery Charging:

4-Stage Charging:	Bulk, Absorption, Float, Equalize		
Temperature compensation	-30mV / °C / 12 Volt		
Coefficient:	Absorption, Float, Equalize, HVD		
Temperature compensated set-points:			

Environmental:

Maximum Operating Altitude	2000 meters		
Operating Temperature	-40°C to +45°C		
Storage Temperature	-40°C to +80°C		
Humidity	100% n.c.		
Tropicalization	Conformally coated PCBs; Marine-rated terminals		